

# PREMIUM SOLUTION





**PREMIUM SOLUTION:  
SCELTI APPOSTA PER TE**

La nostra serie Premium Solution si arricchisce di nuovi prodotti: il contenuto tecnico ed innovativo, frutto di continue ricerche tecnologiche e brevettuali, è affiancato al design ricercato ed elegante di ogni singolo dettaglio. Grazie a queste caratteristiche, e alle nuove finiture, le nostre soluzioni si adattano ai mobili di qualsiasi ambiente, conferendogli un design raffinato e minimalista. Scegli Premium Solution di CAR, dove la tecnica incontra il design!

**PREMIUM SOLUTION:  
CHOSEN FOR YOU**

Our Premium Solution series is enriched with new products: the technical and innovative content, the result of continuous technological and patent research, is combined with the refined and elegant design of every single detail. Thanks to these features, and to the new finishes, our solutions adapt to the furnishing of any environment, giving it a refined and minimalist design. Choose CAR's Premium solution, where technology meets design!

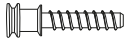

02

**bond**



04

**BLU**



05

**locked**



06

**fix**



07

**PR6820**



09

**levo**



11

**no-one**



13

**hawk**

**MORE THAN JUST  
COMPONENTS**



14

**eagle**



15

**just**



16

**dek**

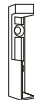

17

**sky series**



19

**sky series**

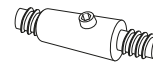

20

**tyson**



PATENT  
PENDING



CACCIAVITE  
SCREWDRIVER



COLLA  
GLUE



# bond



### GIUNZIONE MONOPEZZO INVISIBILE

Può essere impiegato per il fissaggio di pannelli a partire dallo spessore 10 mm, permette di assemblare ogni mobile senza l'uso di ferramenta aggiuntiva. Può essere inserito avvitandolo direttamente sul pannello oppure a pressione. Può essere pre-inserito nei pannelli e nelle soluzioni flat-plack.

### INVISIBLE ONE-PIECE CONNECTING FITTING

It can be used for fixing panels from 10 mm thickness, it allows to assemble each piece of furniture without the use of additional hardware. It can be inserted by screwing it directly on the panel or by pressing. It can be pre-inserted into panels and flat-plack solutions.

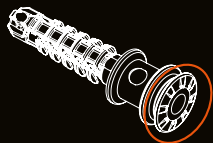

**NUOVA TESTA CON GRIP MIGLIORATO**  
NEW HEAD WITH IMPROVED GRIP

**GIUNZIONE A SCOMPARSА BOND A PRESSIONE**  
BOND PRESSURE RETRACTABLE CONNECTING FITTING

ART.	
GS1202	1500

**GIUNZIONE A SCOMPARSА BOND PER MONTAGGIO DIRETTO**  
BOND RETRACTABLE CONNECTING FITTING FOR DIRECT MOUNTING

ART.	
GS1302	1500

**DISPONIBILE ANCHE VERSIONE "MINI", PER PICCOLI SPESSORI DA 10 A 15 MM.**  
ALSO AVAILABLE IN A "MINI" VERSION, FOR SMALL THICKNESSES FROM 10 TO 15 MM.

ART.	
GS1402	2500

**FINITURE/FINISHES:** .AT

**MATERIALE/MATERIAL:** TECNOPLASTICA-ZAMA/PLASTIC-ZAMAK

### ACCESSORI / ACCESSORIES

ART.	DESCRIZIONE/DESCRIPTION
PF1507.ZB	FRESA PER BOND / MILL FOR BOND
PF2007.ZB	FRESA PER MINI BOND / MILL FOR MINI BOND

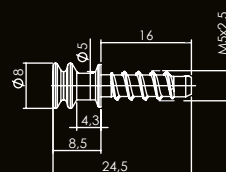
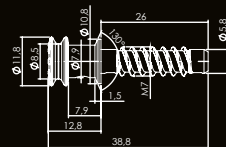
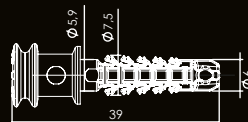

**MONTAGGIO SENZA ATTREZZI.**  
GIUNZIONE FORTE E  
COMPLETAMENTE  
INVISIBILE

**NO TOOL SOLUTIONS**  
STRONG AND COMPLETELY  
INVISIBLE



Montaggio/Assembly

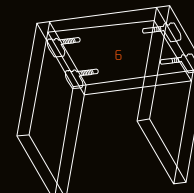
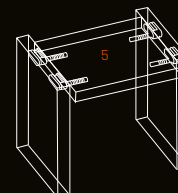
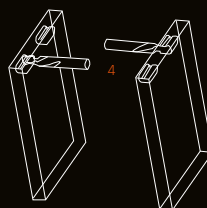
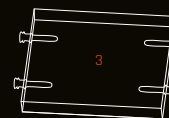
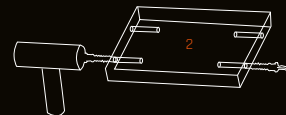
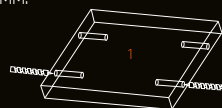



PATENTED

**BLU****GIUNZIONE A SCOMPARSA**

Pratica giunzione monopezzo, è pre-assemblabile e permette un montaggio veloce ed intuitivo. Garantisce un fissaggio solido, in grado di sostenere sollecitazioni e trasporto. BLU Ø 8 assembla pannelli con uno spessore minimo di 12 mm fino a 22 mm, BLU Ø 12 da 18 mm fino a 30 mm. È utilizzabile in tutti gli ambienti e nei mobili flat-pack.

**CONCEALED CONNECTOR**

Practical one-piece connector, it can be pre-assembled and it allows to realize a quick and intuitive assembling. It guarantees a solid fixing, able to support stresses and transport. BLU Ø 8 assembles panels with a minimum thickness of 12 mm up to 22 mm. BLU Ø 12 from 18 mm to 30 mm. It can be used in all environments and in flat-pack furniture.

**BLU8**

ART.	N	S	L	
GSO220..	9,5	41	51	1500

**BLU12**

ART.	N	S	L	
GSO669..	12	41	53	1500

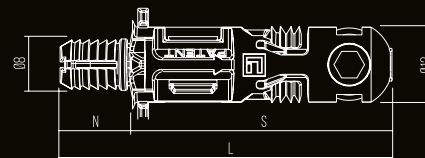
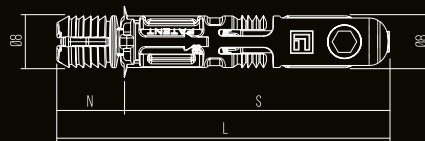

FINITURE/FINISHES: „BL

MATERIALE/MATERIAL: **TEGNOPLASTICA-ZAMA/PLASTIC-ZAMAK**



## VITI DI GIUNZIONE CON TESTA PIATTA

La soluzione ideale per arredi di design, grazie alla sua essenzialità e i raffinati dettagli stilistici. La testa piatta si adatta perfettamente alla superficie del mobile, assicurando un aspetto elegante e minimalista.

## CONNECTING SCREWS WITH FLAT HEAD

The ideal solution for designer furniture, thanks to its simplicity and refined stylistic details. The flat head fits perfectly to the surface of the furniture, ensuring an elegant and minimalist look.



# locked



### TUBETTI DI GIUNZIONE TESTA PIANA CONNECTING SCREWS FLAT HEAD

ART.	L	B	
VG5107..	28	M4	5000
VG6807..	26	M4	5000

### VITI DI GIUNZIONE TESTA PIANA CONNECTING SCREWS FLAT HEAD

ART.	L	B	
VG5207..	15	M4	5000
VG5607..	18	M4	5000
VG6907..	20	M4	5000

FINITURE/FINISHES: ..NI ..NS  
MATERIALE/MATERIAL: FERRO/STEEL

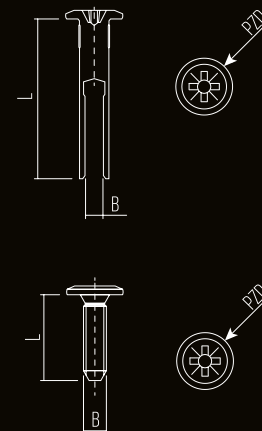



PATENTED

### FERMASCHIENA PREMONTABILE

FIX, mettendo in trazione lo schienale, migliora la stabilità del mobile e riduce i tempi di montaggio. È di facile installazione ed è adatto alle moderne linee di cucine e zone living, senza compromessi su design e funzionalità.

### PRE-ASSEMBLED BACK STOPPER

FIX, by pulling the backrest, improves the stability of the cabinet and reduces assembly time. It is easy to install and is suitable for modern lines of kitchens and living areas, without compromising the design and functionality.



fix



ART.	Ø	L	EX.	📦
FS2215..	10	8	4	5000

FINITURE/FINISHES: ..GR ..ZB  
MATERIALE/MATERIAL: ZAMA/ZAMAK

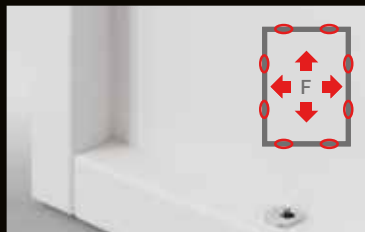

Montaggio/Assembly

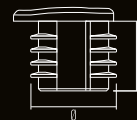



PR6820





**PIEDINO CON FONDELLO E TAPPO**

Un piedino funzionale, idoneo a qualsiasi contesto. Grazie all'anello aggiunto alla base del fondello, quando quest'ultimo va in appoggio sulla testa della vite non entra in contatto con il tappo in plastica, migliorandone il grip.

**LEG WITH INSERT AND CAP**

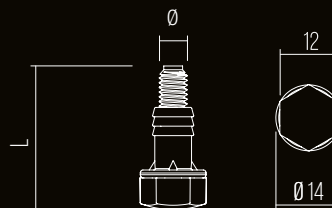
A functional leg, suitable for any context. Thanks to the ring added to the base of the insert, when the latter rests on the head of the screw does not come into contact with the plastic cap, improving the grip.



ART.	Ø	M	L	
PR6120	8	M6	15,5	1250
PR6820	8	M6	27,5	1250

FINITURE/FINISHES: ..BI ..NE ..ZN

MATERIALE/MATERIAL: PLASTICA-FERRO-ZAMA/PLASTIC-STEEL-ZAMA

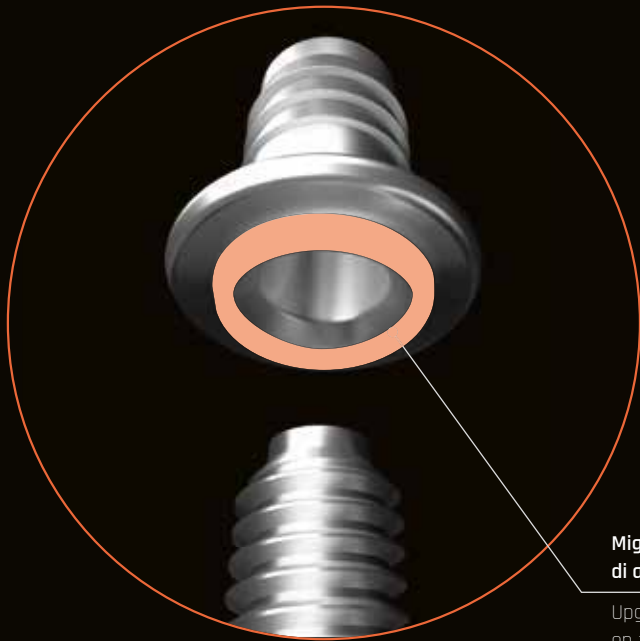

**Miglioramento dell'anello di arresto sulla testa della vite.**

Upgrade to the stop ring on the screw head.

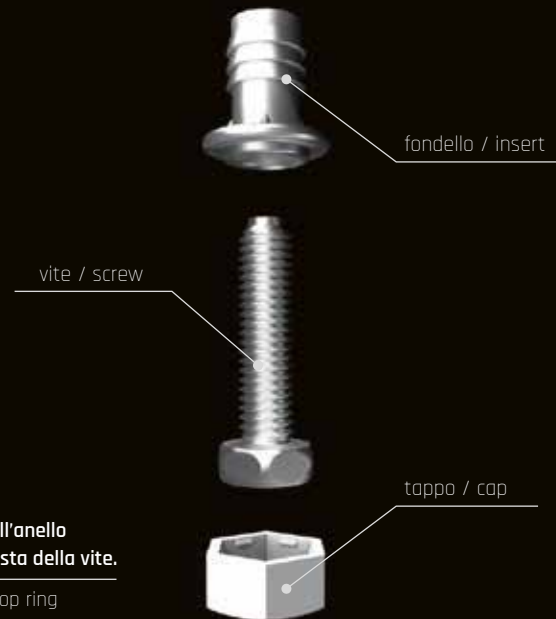

PATENTED



levo



### PIEDINO REGOLABILE A SCOMPARSA

LEVO è il piedino regolabile a scomparsa pre-inseribile sul fianco del mobile, utilizzabile in tutti gli ambienti, per armadi, dispense, librerie e tutti i mobili FLAT-PACK.

### ADJUSTABLE LEG

LEVO is the adjustable leg that can be pre-inserted in the side of the furniture. It can be used in all environments, for wardrobes, pantries, bookcases and all FLAT-PACK furniture.

ART.	Ø	X	L	S	D	R	W
PR8520..	12	24	33	6	9	10	250
PR8920..	12	32	41	6	9	10	250
PR7020..	12	52	61	6	9	25	250
PR7820..	12	70	79	6	9	25	250
PR7920..	12	100	109	6	9	25	200
PR8020..	12	120	133	6	9	25	200
PR9120..	14	32	41	6	9	10	250
PR8120..	14	52	61	6	9	25	250
PR8220..	14	70	79	6	9	25	200
PR8320..	14	120	133	6	9	25	200
PR8420..	14	140	153	6	9	25	200

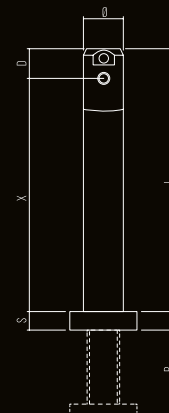

FINITURE/FINISHES: ..GR ..ZN

MATERIALE/MATERIAL: TECNOPLASTICA-FERRO-ZAMA/PLASTIC-STEEL-ZAMA





PATENTED



# no-one



### REGGIPIANO A SCOMPARSA

Reggipiano invisibile. Montaggio veloce con garanzia di anti-ribaltamento. Utilizzabile in tutti i ripiani dal legno al metallo. Esalta le linee essenziali, i materiali ma prima di tutto la tua libertà compositiva.

### INVISIBLE SHELF SUPPORT

Invisible shelf support. Quick installation with anti-overturning guarantee. Usable in all shelves from wood to metal. It enhances the essential lines, the materials but first of all your compositional freedom.

ART.	Ø	Icona
RM9731..	5	1000

FINITURE/FINISHES: ..GG

MATERIALE/MATERIAL: TECNOPLASTICA-ZAMA/PLASTIC-ZAMAK

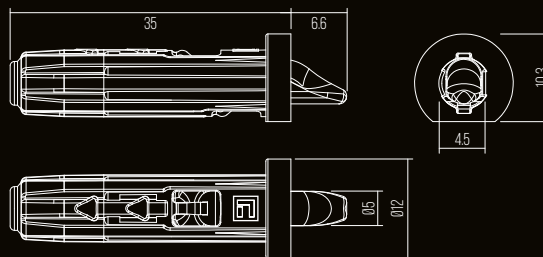

Nuova punta di appoggio  
New support tip

Più resistente / More resistant  
Anti ribaltamento migliorato / Improved anti-overturning  
Smontaggio facile / Easy disassembly

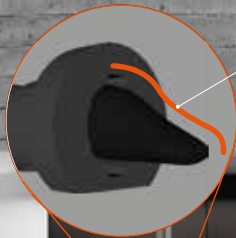

REGISTERED  
COMMUNITY  
DESIGN



hawk



### REGGICRISTALLO NO TOOL

Grazie al suo sistema di fissaggio intuitivo e privo di attrezzi, il reggicristallo ti permette di fissare il ripiano in vetro in modo stabile e sicuro. Hawk consente di trasportare in sicurezza anche mobili con ripiani in cristallo già montati.

### NO TOOL GLASS SUPPORT

Thanks to its intuitive and tool-free fastening system, the glass support allows you to fix the glass shelf in a stable and safe way. Hawk allows you to safely transport even furniture with glass shelves already mounted.

ART.	PERNO/PIN	X	
RM 10269	5	4-8	1000
RM 10369	5	8-12	1000

FINITURE/FINISHES: ..NI ..NN ..RL

MATERIALE/MATERIAL: TECNOPLASTICA-ZAMA/PLASTIC-ZAMAK

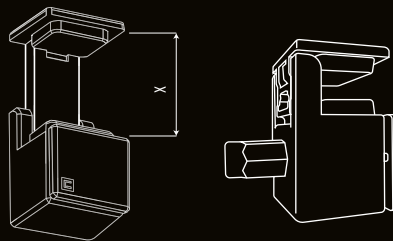

REGISTERED  
COMMUNITY  
DESIGN



eagle



### REGGICRISTALLO HARD LOCK

Caratterizzato da linee pulite e minimali, è disponibile con fissaggio con un perno, a vite o con bussola e vite premontata. Garantisce un fissaggio sicuro e resistente, adatto anche al trasporto di mobili con ripiani in cristallo già installati.

#### HARD LOCK GLASS SUPPORT

Characterized by clean and minimal lines, it is available with a pin, screw, or pre-mounted bush and screw fastening. It guarantees a safe and resistant fixing, also suitable for transporting furniture with glass shelves already installed.

#### REGGICRISTALLI CON PERNO

GLASS SUPPORT WITH PIN

ART.	
RM7969..	1000

#### REGGICRISTALLI BUSSOLA PREMONTATA

GLASS SUPPORT WITH PRE-ASSEMBLED BUSHING

ART.	
RM8020..	1000

#### REGGICRISTALLI CON FORO

GLASS SUPPORT WITH HOLE

ART.	
RM8069..	1000

FINITURE/FINISHES: ..NI ..NN ..RL

MATERIALE/MATERIAL: TECNOPLASTICA-ZAMA/PLASTIC-ZAMAK

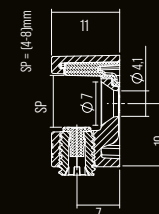
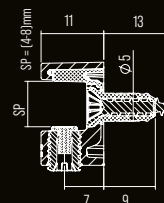
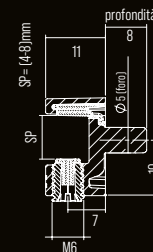

### REGGIPIANO STRUTTURALE

Costruito per essere utilizzato in pannelli di grandi spessori e per essere montato in automatico, può essere installato sia a filo del pannello che in battuta. Il suo design privo di foro a vista lo rende adatto a qualsiasi ambiente. Disponibile in varie finiture in linea con le tendenze del mercato.

### STRUCTURAL SHELF SUPPORT

Built to be used in panels of large thickness and to be mounted automatically, it can be installed both flush with the panel and in a stop. Its hole-free design makes it suitable for any environment. Available in various finishes in line with market trends.



# just



#### SUPPORTO IN PLASTICA PLASTIC SUPPORT

ART.	
IP18202	2000

FINITURE/FINISHES: ..NE  
MATERIALE/MATERIAL: PLASTICA/PLASTIC

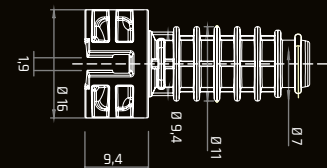

#### STAFFETTA IN ZAMA ZAMAK CONNECTOR

ART.	
IP18315	2000

FINITURE/FINISHES: ..NI ..NN  
MATERIALE/MATERIAL: PLASTICA-ZAMA/PLASTIC-ZAMAK

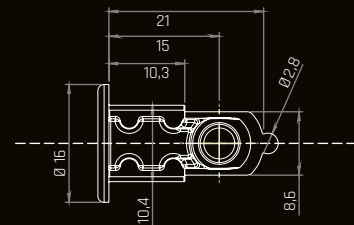

REGISTERED  
COMMUNITY  
DESIGN

### REGGIPIANO STRUTTURALE

Reggipiano idoneo a svolgere anche la funzione di giunzione per pannelli a partire dallo spessore 16 al 30 mm. Montaggio veloce, completamente no-tools, garantisce una forte tenuta strutturale garantendo una linea estetica finale elegante e pulita. Disponibile in varie finiture in linea con le tendenze del mercato.

### STRUCTURAL SHELF SUPPORT

Shelf support also suitable as a connector for thick panels from 16 to 30 mm. Fast assembly, completely no-tools, ensures a strong structural seal giving the aesthetics a clean line. Available in various finishes in line with market trends.

### SUPPORTO IN PLASTICA CON PERNO

PLASTIC SUPPORT WITH METAL PIN

ART.	Ø	L	SP	
IP18469	14	13	16/19	1250
IP11669	14	17,5	22/30	1250

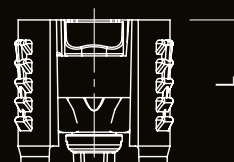

dek



### STAFFETTA IN ZAMA

ZAMAK CONNECTOR

ART.	Ø	L	SP	
IP20815 IP20815/20*	8	13	16	2000
IP20915 IP20915/20*	9,5	14	19	2000
IP21015 IP21015/20*	11	16	22	2000
IP21115 IP21115/20*	12,5	17	25	2000
IP21215 IP21215/20*	15	21	30	2000

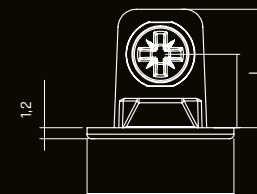
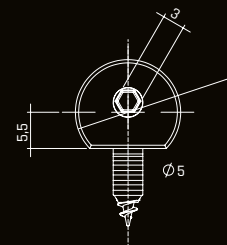

FINITURE/FINISHES: „NI „NN

MATERIALE/MATERIAL: PLASTICA-ZAMA/PLASTIC-ZAMAK

\* /20 STAFFETTA CON VITE PREMONTATA

\* /20 RELAY WITH PRE-ASSEMBLED SCREW



## sky series



### REGGITUBO SKY

Reggitubo dall'estetica ricercata e minimalista. Può essere installato sulla parete o sul lato superiore del mobile, garantendo una perfetta aderenza ed elevata resistenza di carico. Una perfetta sinergia tra stile e funzionalità.

### SKY TUBE SUPPORT

Tube support with refined and minimalist aesthetics. It can be installed in the side panel or in the upper panel of the wardrobe, ensuring a perfect fit and high loading capacity. A perfect synergy between style and functionality.

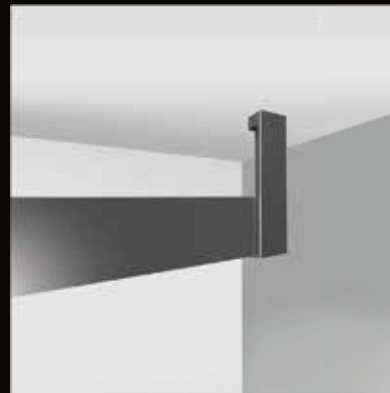



## REGGITUBO LATERALE SIDE TUBE SUPPORT

ART.	X	X1	B	
RT3015.. (DX - R)	32	10	6MA	250
RT3115.. (SX - L)	32	10	6MA	250



## REGGITUBO CENTRALE CENTRAL TUBE SUPPORT

ART.	X	
RT3215	32	250



FINITURE/FINISHES: ..GMO ..MG ..AL ..NI ..CR ..OT  
ALTRE MISURE A RICHIESTA: OTHER MEASURES ON REQUEST



# sky series



## TUBO RETTANGOLARE 30X10 MM

Tubo appendiabiti rettangolare con o senza gomma nella parte superiore, per soddisfare ogni esigenza di progetto. Le finiture e lo stile lineare lo rendono perfetto per armadi moderni, con o senza ante. Da installare esclusivamente con il reggitubo serie SKY.

## RECTANGULAR TUBE 30X10 MM

Rectangular wardrobe tube with or without rubber at the top, to meet every project requirement. The finishes and linear style make it perfect for modern cabinets, with or without doors. To be installed exclusively with the SKY series tube support.

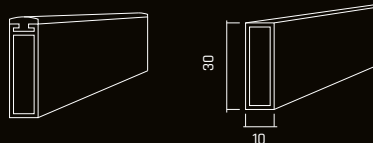

ART.	MM	ART.	MM
TB3507..	438	TB3907..	1158
TB3607..	568	TB4007..	1398
TB3707..	918	TB4107..	1676
TB3807..	1038	TB4207..	2110

ALTRE MISURE A RICHIESTA  
OTHER MEASURES ON REQUEST

FINITURE/FINISHES: ..GMO ..GG ..NI ..CR ..MG ..OT

MATERIALE/MATERIAL: ZAMA/ZAMAK



tyson

#### GIUNZIONE AD ALTE PRESTAZIONI

Tyson è progettato per offrire una tenuta sicura e affidabile, anche sotto carichi elevati. La sua struttura garantisce stabilità e previene la deformazione del mobile, assicurandone l'integrità nel tempo. Grazie alla sua capacità di regolazione, è ideale per applicazioni che richiedono precisione, contribuendo a mantenere il mobile in perfette condizioni anche dopo un utilizzo prolungato.

#### HIGH-PERFORMANCE ADJUSTABLE TIE ROD

Tyson is designed to provide secure and reliable fastening, even under heavy loads. Its structure ensures stability and prevents the deformation of the furniture, preserving its integrity over time. Thanks to its adjustable feature, it is ideal for applications requiring precision, helping to keep the furniture in perfect condition even after prolonged use.

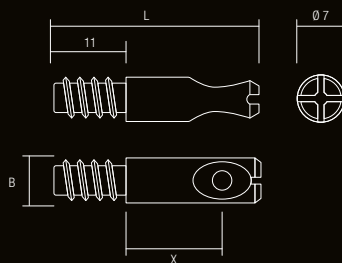
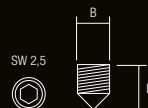
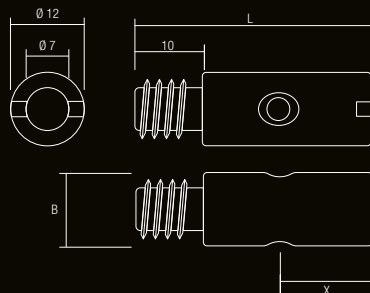

ART.	Ø	L	X	B	
TT10507	12	37	18	FL8	2000
TT10807	12	37	18	M6	2000

FINITURE/FINISHES: ..ZB  
MATERIALE/MATERIAL: FERRO/STEEL

ART.	B	L	
VT2907.ZB	M5	6	2000
VT2907.ZN	M5	6	2000

FINITURE/FINISHES: ..ZB, ..ZN  
MATERIALE/MATERIAL: FERRO/STEEL

ART.	Ø	L	X	B	
TT10607	7	33,5	18	M6	2000
TT10707	7	33,5	18	M4	2000
TT11007	7	33,5	18	EURO 6	2000

FINITURE/FINISHES: ..ZB  
MATERIALE/MATERIAL: FERRO/STEEL

#### ACCESSORI / ACCESSORIES

ART.	DESCRIZIONE/DESCRIPTION
PF1807.ZB	FRESA / MILL
CH1307.ZB	INSERTO AVVITATORE / SCREWDRIIVER INSERT



Montaggio/Assembling

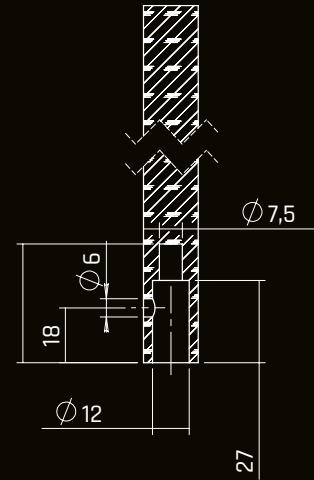
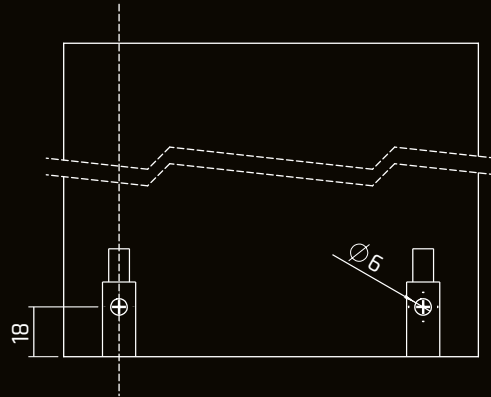
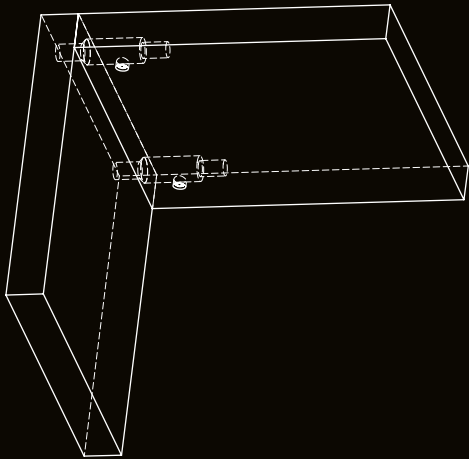

PREMIUM SOLUTION, DOVE LA TECNICA INCONTRA IL DESIGN!  
Scopri di più sul nostro sito [www.car-fittings.it](http://www.car-fittings.it)

PREMIUM SOLUTION, WHERE TECHNOLOGY MEETS DESIGN!  
Find out more at [www.car-fittings.it](http://www.car-fittings.it)



Via Germania, 21 - 35127 Padova - Italy  
Phone: +39 049.870.0944 - Email: [commerce@car-fittings.it](mailto:commerce@car-fittings.it)

[www.car-fittings.it](http://www.car-fittings.it) |    