

PREMIUM SOLUTION



**PREMIUM SOLUTION:
SCELTI APPOSTA PER TE**

La nostra serie Premium Solution si arricchisce di nuovi prodotti: il contenuto tecnico ed innovativo, frutto di continue ricerche tecnologiche e brevettuali, è affiancato al design ricercato ed elegante di ogni singolo dettaglio. Grazie a queste caratteristiche, e alle nuove finiture, le nostre soluzioni si adattano ai mobili di qualsiasi ambiente, conferendogli un design raffinato e minimalista. Scegli Premium Solution di CAR, dove la tecnica incontra il design!

**PREMIUM SOLUTION:
CHOSEN FOR YOU**

Our Premium Solution series is enriched with new products: the technical and innovative content, the result of continuous technological and patent research, is combined with the refined and elegant design of every single detail. Thanks to these features, and to the new finishes, our solutions adapt to the furnishing of any environment, giving it a refined and minimalist design. Choose CAR's Premium solution, where technology meets design!

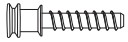

02

bond



03

BLU



04

locked



05

fix



06

PR6820



08

levo

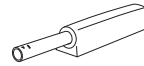

10

car-matic



12

no-one

MORE THAN JUST COMPONENTS



14

hawk



15

eagle



16

just



17

dek

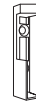

18

sky series

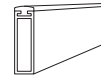

20

sky series

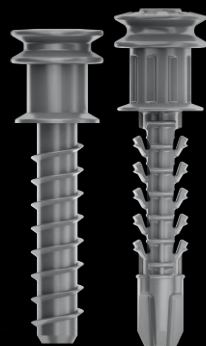

bond



GIUNZIONE MONOPEZZO INVISIBILE

Può essere impiegato per il fissaggio di pannelli a partire dallo spessore 16 mm, permette di assemblare ogni mobile senza l'uso di ferramenta aggiuntiva. Può essere inserito avvvitandolo direttamente sul pannello oppure a pressione. Ideale per mobili in kit, può essere pre-inserito nei pannelli e nelle soluzioni flat-plack.

INVISIBLE ONE-PIECE CONNECTING FITTING

It can be used for fixing panels from 16 mm thickness, it allows to assemble each piece of furniture without the use of additional hardware. It can be inserted by screwing it directly on the panel or by pressing. Ideal for kit furniture, it can be pre-inserted into panels and flat-plack solutions.

GIUNZIONE A SCOMPARSA BOND A PRESSIONE

BOND PRESSURE RETRACTABLE CONNECTING FITTING

ART.	
GS1202	1000

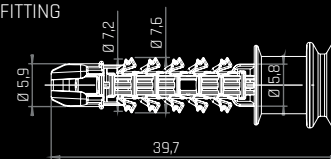

GIUNZIONE A SCOMPARSA BOND PER MONTAGGIO DIRETTO

BOND RETRACTABLE CONNECTING FITTING FOR DIRECT MOUNTING

ART.	
GS1302	1000

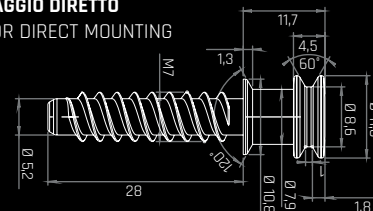



BLU



GIUNZIONE A SCOMPARSA

Pratica giunzione monopezzo, è pre-assemblabile e permette un montaggio veloce ed intuitivo. Garantisce un fissaggio solido, in grado di sostenere sollecitazioni e trasporto. BLU Ø 8 assembla pannelli con uno spessore minimo di 12 mm fino a 22 mm, BLU Ø 12 da 18 mm fino a 30 mm. È utilizzabile in tutti gli ambienti e nei mobili flat-pack.

CONCEALED CONNECTOR

Practical one-piece connector, it can be pre-assembled and it allows to realize a quick and intuitive assembling. It guarantees a solid fixing, able to support stresses and transport. BLU Ø 8 assembles panels with a minimum thickness of 12 mm up to 22 mm. BLU Ø 12 from 18 mm to 30 mm. It can be used in all environments and in flat-pack furniture.

BLU8

ART.	N	S	L	
GSD220..	9,5	41	51	1500

BLU12

ART.	N	S	L	
GSD669..	12	41	53	1500

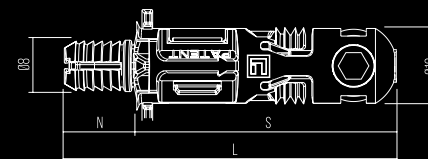
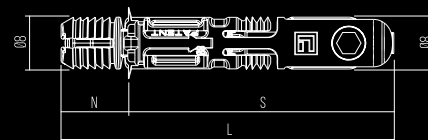



VITI DI GIUNZIONE CON TESTA PIATTA

La soluzione ideale per arredi di design, grazie alla sua essenzialità e i raffinati dettagli stilistici. La testa piatta si adatta perfettamente alla superficie del mobile, assicurando un aspetto elegante e minimalista.

CONNECTING SCREWS WITH FLAT HEAD

The ideal solution for designer furniture, thanks to its simplicity and refined stylistic details. The flat head fits perfectly to the surface of the furniture, ensuring an elegant and minimalist look.

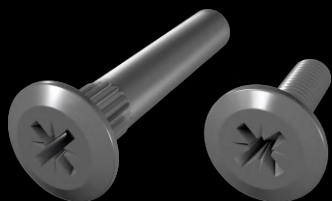

locked



TUBETTI DI GIUNZIONE TESTA PIANA CONNECTING SCREWS FLAT HEAD

ART.	L	B	
VG5107..	28	M4	5000
VG6807..	26	M4	5000

VITI DI GIUNZIONE TESTA PIANA CONNECTING SCREWS FLAT HEAD

ART.	L	B	
VG5207..	15	M4	5000
VG5607..	18	M4	5000
VG6907..	20	M4	5000

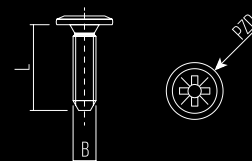
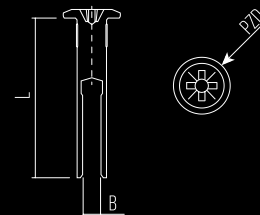



FERMASCHIENA PREMONTABILE

FIX, mettendo in trazione lo schienale, migliora la stabilità del mobile e riduce i tempi di montaggio. È di facile installazione ed è adatto alle moderne linee di cucine e zone living, senza compromessi su design e funzionalità.



PRE-ASSEMBLED BACK STOPPER

FIX, by pulling the backrest, improves the stability of the cabinet and reduces assembly time. It is easy to install and is suitable for modern lines of kitchens and living areas, without compromising the design and functionality.

ART.	Ø	L	EX.	
FS2215..	10	8	4	5000

fix

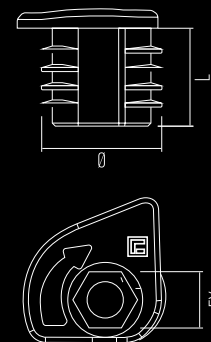

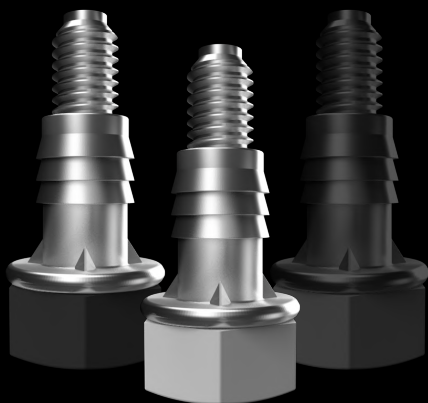

PR6820



PIEDINO CON FONDELLO E TAPPO

Un piedino funzionale, idoneo a qualsiasi contesto. Grazie all'anello aggiunto alla base del fondello, quando quest'ultimo va in appoggio sulla testa della vite non entra in contatto con il tappo in plastica, migliorandone il grip.

LEG WITH INSERT AND CAP

A functional leg, suitable for any context. Thanks to the ring added to the base of the insert, when the latter rests on the head of the screw does not come into contact with the plastic cap, improving the grip.

ART.	
PR6820	1250

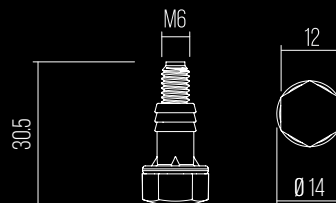
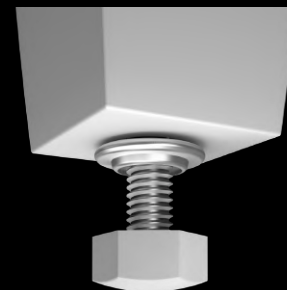

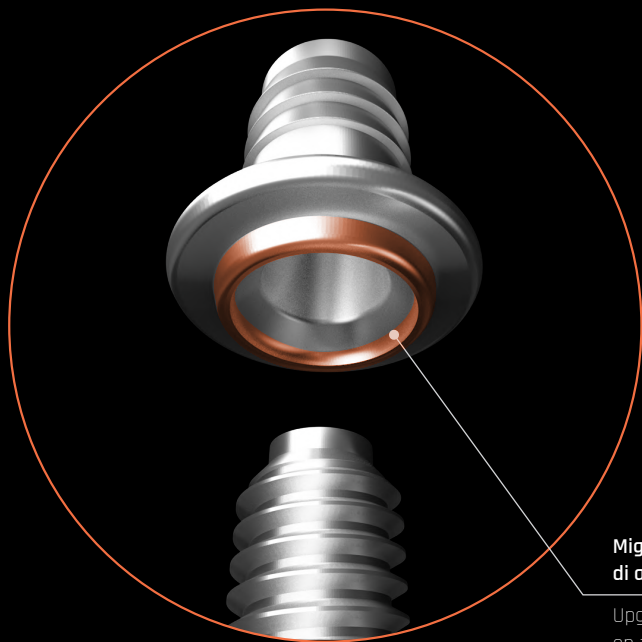

**Miglioramento dell'anello
di arresto sulla testa della vite.**

Upgrade to the stop ring
on the screw head.

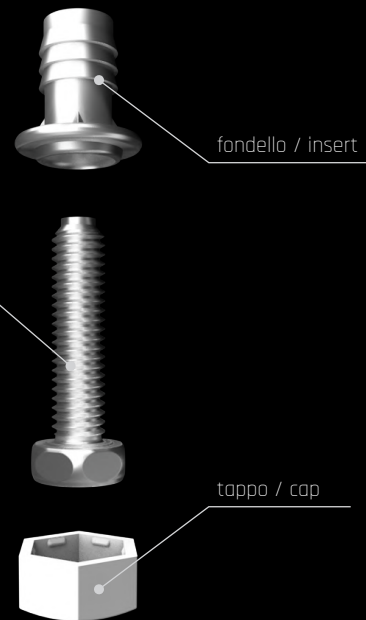



levo



PIEDINO REGOLABILE A SCOMPARSA

LEVO è il piedino regolabile a scomparsa pre-inseribile sul fianco del mobile, utilizzabile in tutti gli ambienti, per armadi, dispense, librerie e tutti i mobili FLAT-PACK.

ADJUSTABLE LEG

LEVO is the adjustable leg that can be pre-inserted in the side of the furniture. It can be used in all environments, for wardrobes, pantries, bookcases and all FLAT-PACK furniture.

ART.	Ø	X	L	S	D	R	
PR8520..	12	24	33	6	9	10	250
PR8920..	12	32	41	6	9	10	250
PR7020..	12	52	61	6	9	25	250
PR7820..	12	70	79	6	9	25	250
PR7920..	12	100	109	6	9	25	200
PR8020..	12	120	133	6	9	25	200
PR9120..	14	32	41	6	9	10	250
PR8120..	14	52	61	6	9	25	250
PR8220..	14	70	79	6	9	25	200
PR8320..	14	120	133	6	9	25	200
PR8420..	14	140	153	6	9	25	200

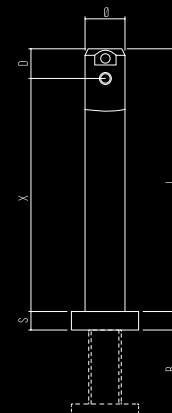





car-matic



SISTEMA DI APERTURA PUSH&PULL

Disponibile sia con paracolpo che con magnete, può essere installato sia ad incasso che sul fianco del cabinet, abbinandolo alla cover dal design essenziale. Garantisce massima libertà di design e praticità, grazie all'apertura e chiusura con una molla forte, silenziosa e dal movimento fluido e duraturo nel tempo.

PUSH&PULL OPENING SYSTEM

Available with both bumper and magnet, it can be installed either recessed or on the side of the cabinet, combining it with the cover with an essential design. It guarantees maximum design freedom and practicality: a strong spring provides a silent, fluid and long-lasting opening and closing movement.





PUSH AD INCASSO CON MAGNETE 37 MM

BUILT-IN 37MM PUSH

ART.	DESCRIZIONE / DESCRIPTION	MOLLA / SPRING	
CP2031	CON MAGNETE / WITH MAGNET	STANDARD	200
CP2131	CON PARACOLPO / WITH BUMPER	STANDARD	200
CP2331	CON MAGNETE / WITH MAGNET	STRONG	200
CP2431	CON PARACOLPO / WITH BUMPER	STRONG	200

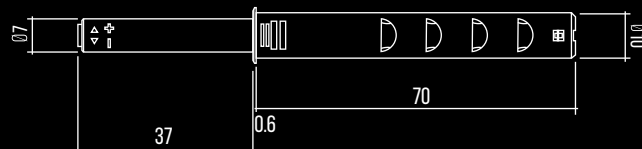

COVER E BASETTA LINEARE

COVER AND LINEAR PLATE

ART.	FISSAGGIO / FIXING	
CP2202	VITE TSP / TSP SCREW	200
CP2502	EUROVITE / EUROScrew	200

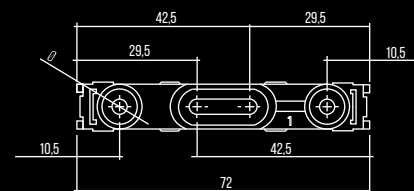
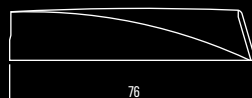

CONTROPIASTRA

COUNTERPLATE

ART.	DESCRIZIONE / DESCRIPTION	
CA0307	C/CHiodo D.10 / W/NAIL D.10	200
CA0407	T/GROCE D.10 / CROSS HEAD D.10	200
CA0607	ADESIVA D.10 / ADHESIVE D.10	200

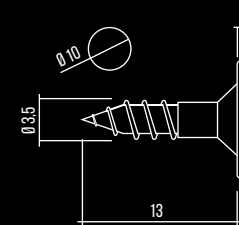
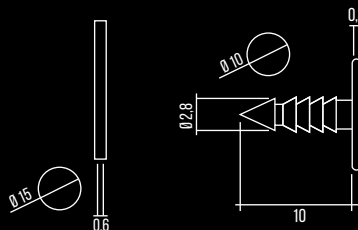



no-one



REGGIPIANO A SCOMPARSA

Reggiplane invisibile. Montaggio veloce, senza tools, con garanzia di anti-ribaltamento. Utilizzabile in tutti i ripiani dal legno al metallo. Esalta le linee essenziali, i materiali ma prima di tutto la tua libertà compositiva.

INVISIBLE SHELF SUPPORT

Invisible shelf support. Quick installation, without tools, with anti-overturning guarantee. Usable in all shelves from wood to metal. It enhances the essential lines, the materials but first of all your compositional freedom.

ART.	Ø	📦
RM9731..	5	1000

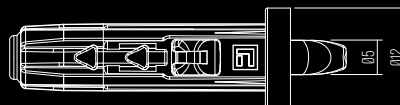
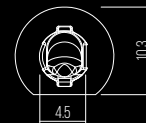
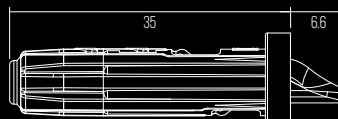



Nuova punta di appoggio
New support tip

Più resistente / More resistant
Anti ribaltamento migliorato / Improved anti-averturning
Smontaggio facile / Easy disassembly

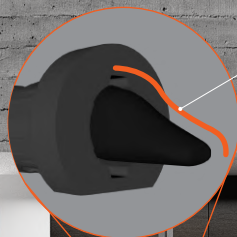



hawk



REGGICRISTALLO NO TOOL

Grazie al suo sistema di fissaggio intuitivo e privo di attrezzi, il reggicristallo ti permette di fissare il ripiano in vetro in modo stabile e sicuro. Hawk consente di trasportare in sicurezza anche mobili con ripiani in cristallo già montati.

NO TOOL GLASS SUPPORT

Thanks to its intuitive and tool-free fastening system, the glass support allows you to fix the glass shelf in a stable and safe way. Hawk allows you to safely transport even furniture with glass shelves already mounted.

ART.	PERNO/PIN	X	
RM 10269	5	4-8	1000
RM 10369	5	8-12	1000

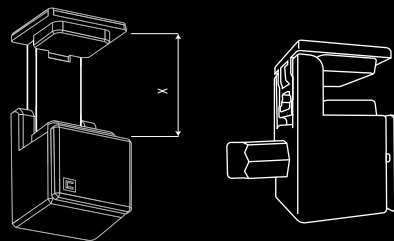



eagle



REGGICRISTALLO HARD LOCK

Caratterizzato da linee pulite e minimali, è disponibile con fissaggio a vite o con un perno. Garantisce un fissaggio sicuro e resistente, adatto anche al trasporto di mobili con ripiani in cristallo già installati.

HARD LOCK GLASS SUPPORT

Characterized by clean and minimal lines, it is available with screw fastening or with a pin. It guarantees a safe and resistant fixing, also suitable for transporting furniture with glass shelves already installed.

REGGICRISTALLI CON FORO GLASS SUPPORT WITH HOLE

ART.	
RM8069..	1000

REGGICRISTALLI CON PERNO GLASS SUPPORT WITH PIN

ART.	
RM7969..	1000

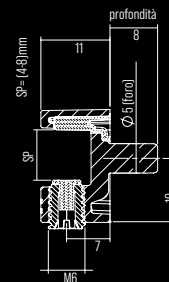
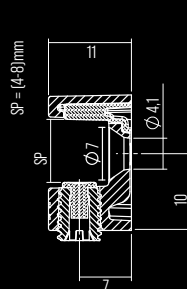

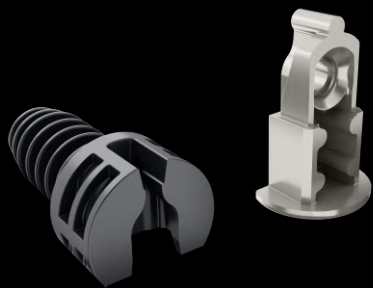

just



REGGIPIANO STRUTTURALE

Costruito per essere utilizzato in pannelli di grandi spessori e per essere montato in automatico, può essere installato sia a filo del pannello che in battuta. Il suo design privo di foro a vista lo rende adatto a qualsiasi ambiente. Disponibile in varie finiture in linea con le tendenze del mercato.

STRUCTURAL SHELF SUPPORT

Built to be used in panels of large thickness and to be mounted automatically, it can be installed both flush with the panel and in a stop. Its hole-free design makes it suitable for any environment. Available in various finishes in line with market trends.

SUPPORTO IN PLASTICA

PLASTIC SUPPORT

ART.	
IP18202	2000

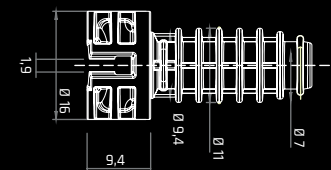

STAFFETTA IN ZAMA

ZAMAK CONNECTOR

ART.	
IP18315	2000

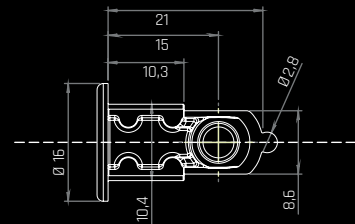

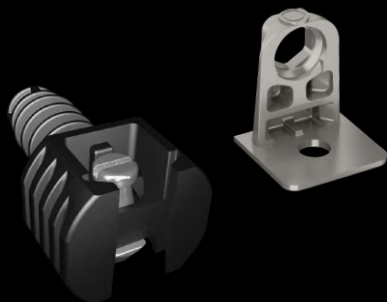

dek



REGGIPIANO STRUTTURALE

Reggipiano idoneo a svolgere anche la funzione di giunzione per pannelli di grandi spessori (da 25 mm in su). Montaggio veloce, completamente no-tools, garantisce una forte tenuta strutturale garantendo una linea estetica finale elegante e pulita. Disponibile in varie finiture in linea con le tendenze del mercato.

STRUCTURAL SHELF SUPPORT

Shelf support also suitable as a connector for thick panels (from 25 mm upwards). Fast assembly, completely no-tools, ensures a strong structural seal giving the aesthetics a clean line. Available in various finishes in line with market trends.

SUPPORTO IN PLASTICA CON PERNO

PLASTIC SUPPORT WITH METAL PIN

ART.	
IP19202	2000

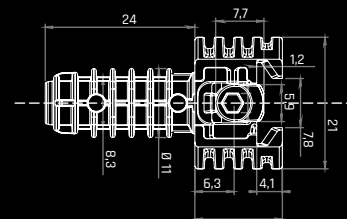

STAFFETTA IN ZAMA

ZAMAK CONNECTOR

ART.	
IP19315	2000

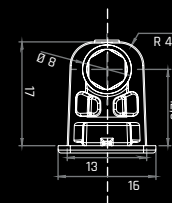



sky series



REGGITUBO SKY

Reggitubo dall'estetica ricercata e minimalista. Può essere installato sulla parete o sul lato superiore del mobile, garantendo una perfetta aderenza ed elevata resistenza di carico. Una perfetta sinergia tra stile e funzionalità.

SKY TUBE SUPPORT

Tube support with refined and minimalist aesthetics. It can be installed in the side panel or in the upper panel of the wardrobe, ensuring a perfect fit and high loading capacity. A perfect synergy between style and functionality.

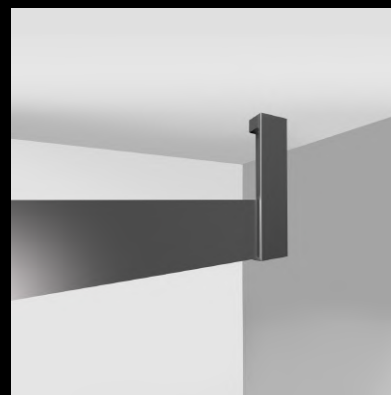



REGGITUBO LATERALE

SIDE TUBE SUPPORT

ART.	X	X1	B	
RT3015.. (DX - R)	32	10	6MA	250
RT3115.. (SX - L)	32	10	6MA	250

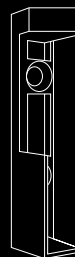

REGGITUBO CENTRALE

CENTRAL TUBE SUPPORT

ART.	X	
RT3215	32	250



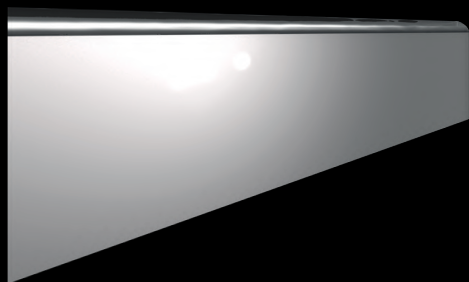

sky series



TUBO RETTANGOLARE 30X10 MM

Tubo appendiabiti rettangolare con o senza gomma nella parte superiore, per soddisfare ogni esigenza di progetto. Le finiture e lo stile lineare lo rendono perfetto per armadi moderni, con o senza ante. Da installare esclusivamente con il reggitubo serie SKY.

RECTANGULAR TUBE 30X10 MM

Rectangular wardrobe tube with or without rubber at the top, to meet every project requirement. The finishes and linear style make it perfect for modern cabinets, with or without doors. To be installed exclusively with the SKY series tube support.

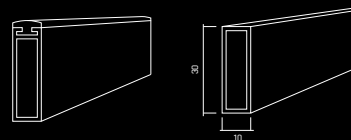

ART.	MM
TB3507..	438
TB3607..	558
TB3707..	918
TB3807..	1038

ART.	MM
TB3907..	1158
TB4007..	1398
TB4107..	1676
TB4207..	2110

OTHER MEASURES ON REQUEST
ALTRE MISURE A RICHIESTA

PREMIUM SOLUTION, DOVE LA TECNICA INCONTRA IL DESIGN!

Scopri di più sul nostro sito www.car-fittings.it

PREMIUM SOLUTION, WHERE TECHNOLOGY MEETS DESIGN!

Find out more at www.car-fittings.it



Via Germania, 21 - 35127 Padova - Italy
Phone: +39 049.870.0944 - Email: commerce@car-fittings.it

www.car-fittings.it | [in](#) [m](#) [@](#) [f](#)